

# PTO GEAR PUMP RANGE

## Pump Specifications

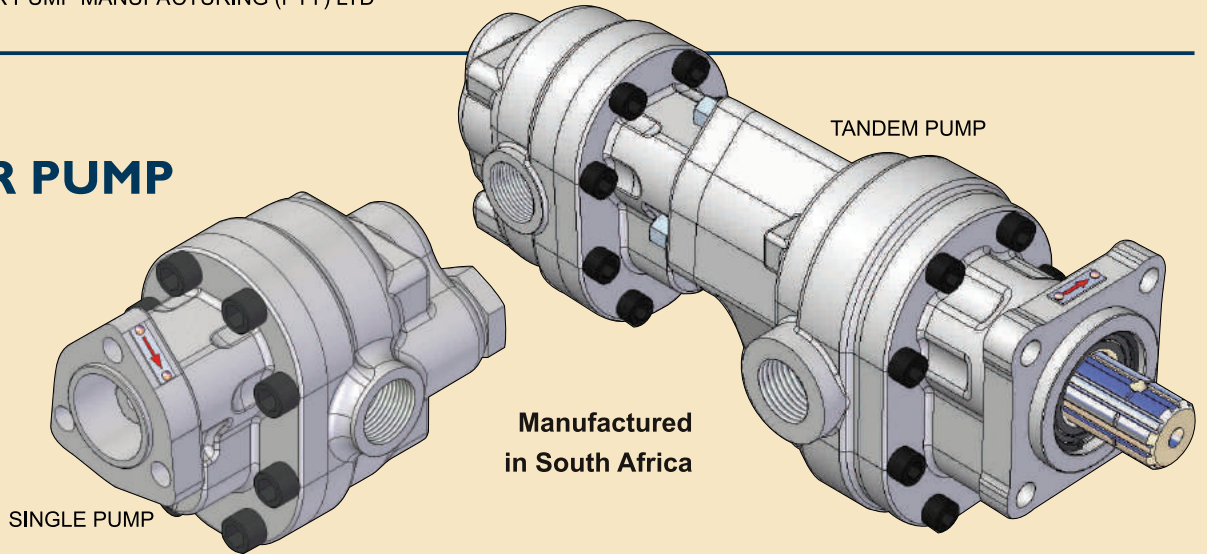

<b>GP3</b> SINGLE PUMP	cc/rev	Lpm (at 1000rpm)	cu in (cu in/rev)	Max Pressure ( bar )	Max Pressure ( psi )	Max Speed (rpm)	Pump Weight (kg)
024	24.10	24.10	1.48	300	4300	3000	9.20
032	32.20	32.20	1.97	300	4300	3000	9.75
040	40.30	40.30	2.46	300	4300	3000	10.00
048	48.30	48.30	2.96	300	4300	3000	10.65
052	52.10	52.10	3.19	300	4300	2400	11.25
062	62.60	62.60	3.82	300	4300	2400	11.85
073	73.50	73.50	4.49	270	3900	2400	15.00
080	80.60	80.60	4.92	270	3900	2400	15.15
088	88.00	88.00	5.37	270	3900	2400	15.25
102	102.00	102.00	6.22	240	3500	2400	15.90
118	118.00	118.00	7.20	240	3500	2400	16.25
132	132.60	132.60	8.09	220	3200	2400	16.30
147	147.00	147.00	8.97	200	3000	2400	17.30

<b>GP3T</b> TANDEM PUMP	cc/rev	Lpm (at 1000rpm)	cu in (cu in/rev)	Max Pressure ( bar )	Max Pressure ( psi )	Max Speed (rpm)	Pump Weight (kg)
052	52.10	52.10	3.19	300	4300	2400	12.90
062	62.60	62.60	3.82	300	4300	2400	13.65
073	73.50	73.50	4.49	270	3900	2400	16.10
080	80.60	80.60	4.92	270	3900	2400	16.55
088	88.00	88.00	5.37	270	3900	2400	16.80

THE ABOVE DATA ARE AVERAGE RESULTS BASED ON A SERIES OF TESTS AND ARE NOT NECESSARILY REPRESENTATIVE OF ANY SINGLE UNIT. GEAR PUMP MANUFACTURING RESERVES THE RIGHT TO AMEND THE TECHNICAL DATA WITHOUT NOTICE.

**SINGLE PUMP ORDER CODES - EXAMPLE:**

**GP3 - 080 - D - R**

<b>SERIES</b>	<b>SIZE</b>	<b>MOUNT</b>	<b>ROTATION</b>
GP3	080	D	R
	024 032 040 048 052 062 073 080 088 102 118 132 147	D (DIN 4 bolt) U (UNI 3 bolt) S (SAE B 2 bolt) A (AUS 4 bolt)	L (Left hand / Counterclockwise) R (Right hand / Clockwise)

**TANDEM PUMP ORDER CODES - EXAMPLE:**

**GP3T - 080 - 032 - D - R**

<b>SERIES</b>	<b>FRONT SIZE</b>	<b>REAR SIZE</b>	<b>MOUNT</b>	<b>ROTATION</b>
GP3T	080	032	D	R
	052 062 073 080 088	024 032 040 048 052 062 073 080	D (DIN 4 bolt)	L (Left hand / Counterclockwise) R (Right hand / Clockwise)

Useful Formulae	To Convert	Inches	Bar	Cu In/rev	US GPM	US GPM	kg
	Into	Millimeters	Psi	cc/rev	Cu In/rev	cc/rev	lbs
	Multiply by	25.4	14.5	16.39	2.31	3.785	2.205

# PTO GEAR PUMP OPTIONS

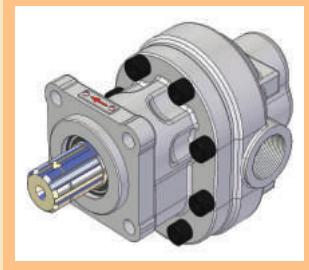

### DIN

**MOUNT** 4 Holes (80 x 80)  
**PCD** 113,5 mm  
**SPIGOT** 80 mm  
**SHAFT** 8 Spline  
**SHAFT OD** 34,8 mm

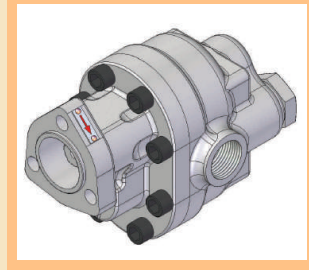

### UNI

**MOUNT** 3 Holes  
**PCD** 72 mm  
**SPIGOT** 52 mm  
**SHAFT** 6 Spline  
**SHAFT OD** 24,6 mm

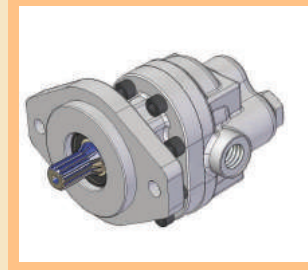

### SAE

**MOUNT** 2 Holes  
**PCD** 146 mm  
**SPIGOT** 101,6 mm  
**SHAFT** 13 Spline  
**SHAFT OD** 22,2 mm

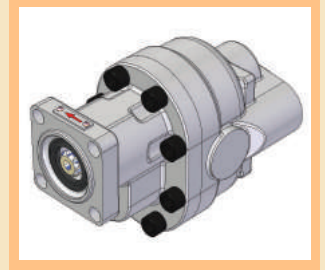

### AUS

**MOUNT** 4 Holes (58 X 58)  
**PCD** 82,5 mm  
**SPIGOT** 62 mm  
**SHAFT** 8 Spline  
**SHAFT OD** 22 mm

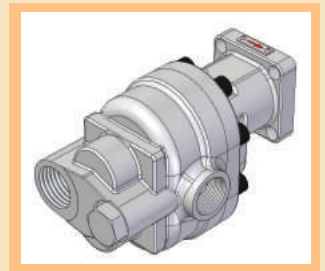
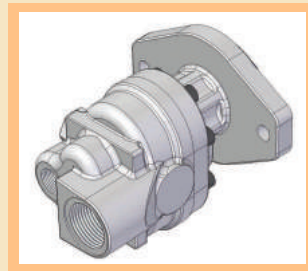
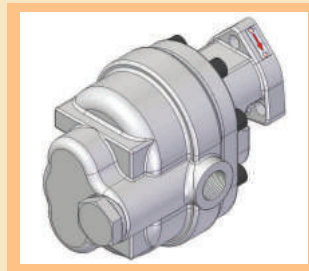
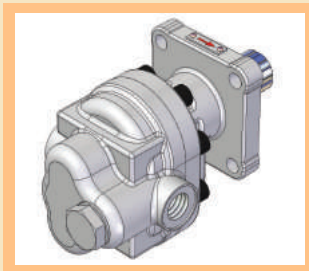

## PORTING SIZES

### SINGLE PUMP PORTING

DIN and UNI				SAE and AUS			
Size	Inlet Side	Outlet 1 Side	Outlet 2 Rear	Size	Inlet Rear	Outlet 1 Rear	Outlet 2 Side
GP3-024	1" bsp	3/4" bsp	3/4" bsp	GP3-024	1 1/4" odt	3/4" odt	3/4" odt
GP3-032	1" bsp	3/4" bsp	3/4" bsp	GP3-032	1 1/4" odt	3/4" odt	3/4" odt
GP3-040	1" bsp	3/4" bsp	3/4" bsp	GP3-040	1 1/4" odt	3/4" odt	3/4" odt
GP3-048	1" bsp	3/4" bsp	3/4" bsp	GP3-048	1 1/4" odt	3/4" odt	3/4" odt
GP3-052	1" bsp	1" bsp	1" bsp	GP3-052	1 1/4" odt	3/4" odt	3/4" odt
GP3-062	1" bsp	1" bsp	1" bsp	GP3-062	1 1/4" odt	3/4" odt	3/4" odt
GP3-073	1 1/4" bsp	1" bsp	1" bsp	GP3-073	1 1/4" odt	3/4" odt	3/4" odt
GP3-080	1 1/4" bsp	1" bsp	1" bsp	GP3-080	1 1/2" odt	1" odt	1" odt
GP3-088	1 1/4" bsp	1" bsp	1" bsp	GP3-088	1 1/2" odt	1" odt	1" odt
GP3-102	1 1/4" bsp	1" bsp	1" bsp	GP3-102	1 1/2" odt	1" odt	1" odt
GP3-118	1 1/4" bsp	1" bsp	1" bsp	GP3-118	1 1/2" odt	1" odt	1" odt
GP3-132	1 1/2" bsp	1" bsp	1" bsp	GP3-132	1 1/2" odt	1" odt	1" odt
GP3-147	1 1/2" bsp	1" bsp	1" bsp	GP3-147	1 1/2" odt	1" odt	1" odt

### TANDEM PUMP PORTING

Front Pump			Rear Pump			
Size	Inlet Side	Outlet Rear	Size	Inlet Side	Outlet 1 Side	Outlet 2 Rear
GP3T-052	1" bsp	1" bsp	GP3-024	1" bsp	3/4" bsp	3/4" bsp
GP3T-062	1" bsp	1" bsp	GP3-032	1" bsp	3/4" bsp	3/4" bsp
GP3T-073	1 1/4" bsp	1" bsp	GP3-040	1" bsp	3/4" bsp	3/4" bsp
GP3T-080	1 1/4" bsp	1" bsp	GP3-048	1" bsp	3/4" bsp	3/4" bsp
GP3T-088	1 1/4" bsp	1" bsp	GP3-052	1" bsp	1" bsp	1" bsp
			GP3-062	1" bsp	1" bsp	1" bsp
			GP3-073	1 1/4" bsp	1" bsp	1" bsp
			GP3-080	1 1/4" bsp	1" bsp	1" bsp